

Wand in 3D eingefärbt

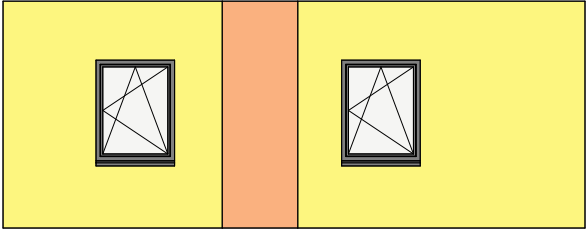

S3

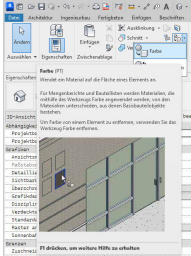

Wand in 3D eingefärbt

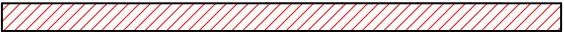
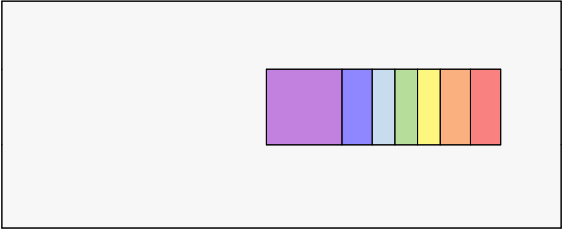

S3

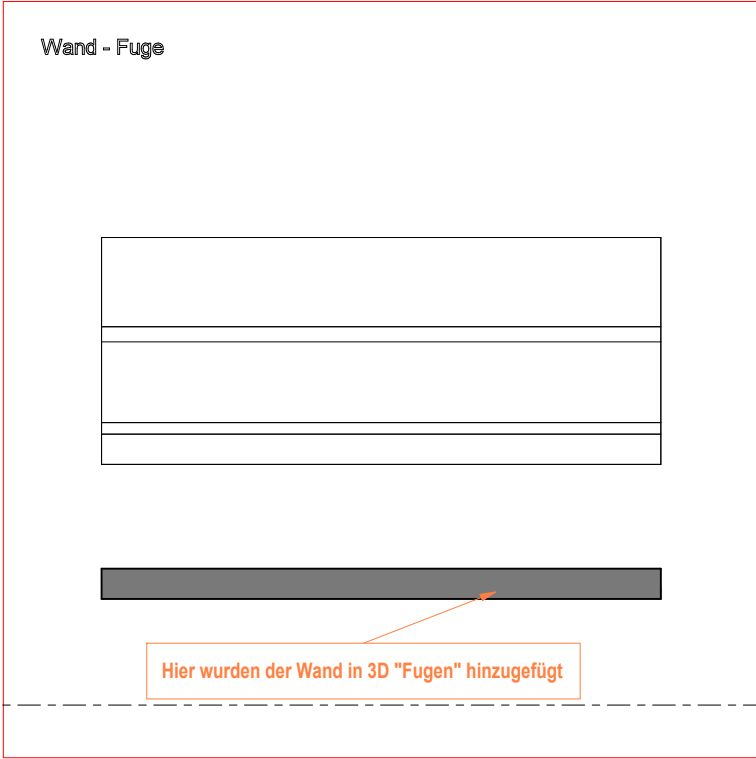
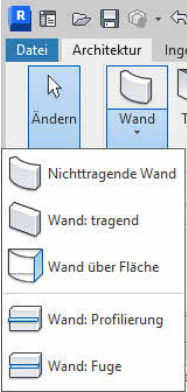
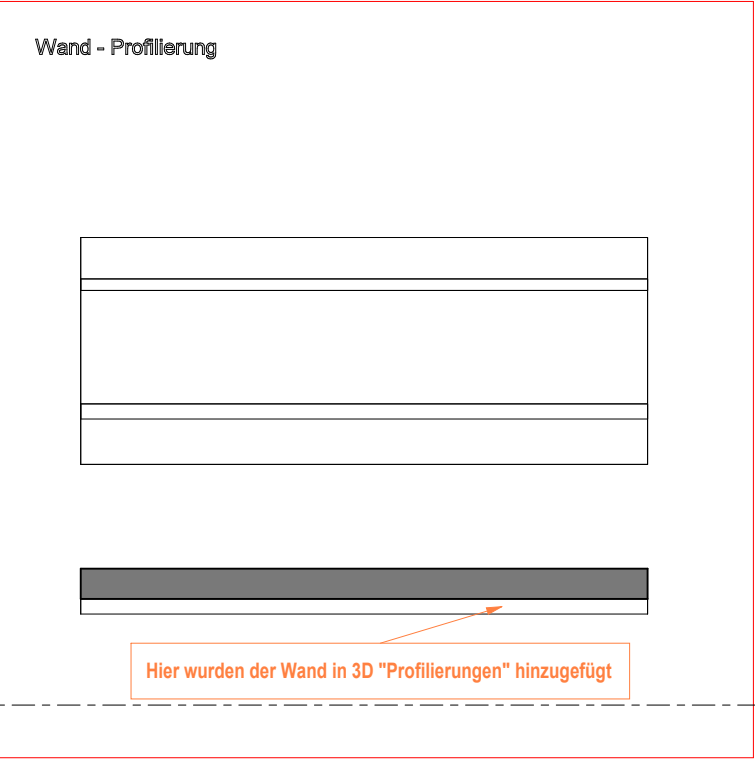

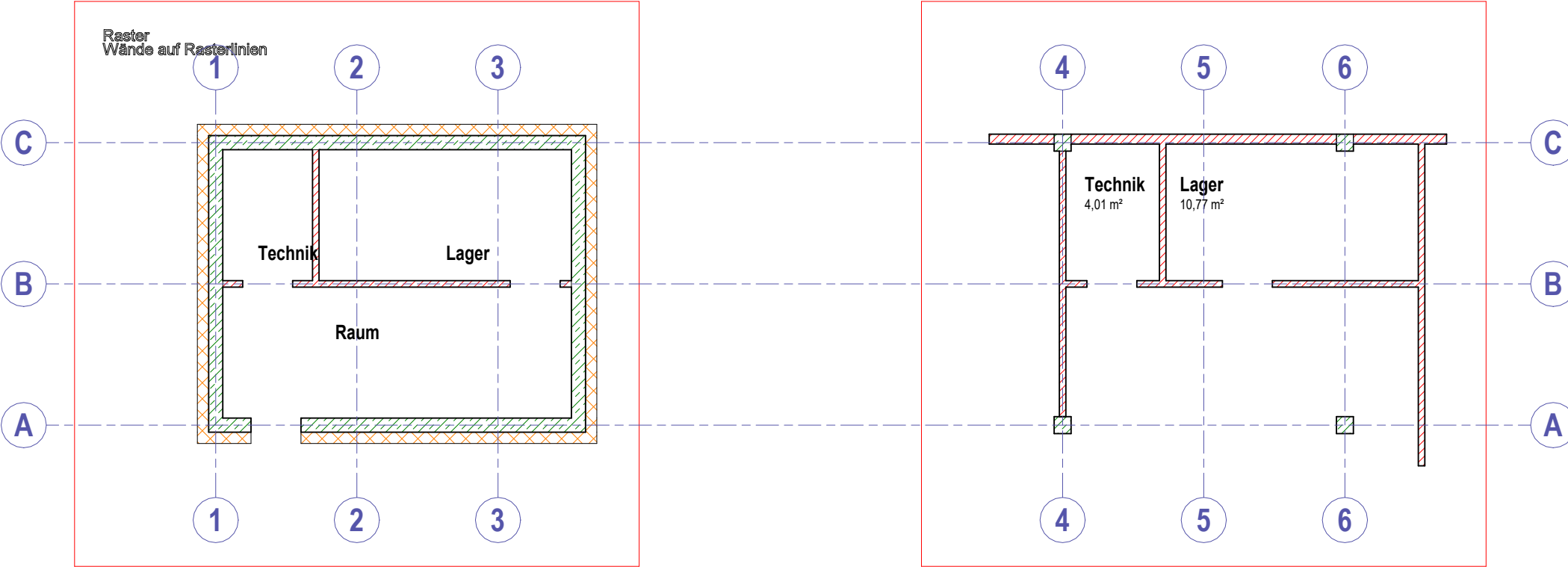

D:\Seaffile\lat-cad\drma\1\docs\themen\60_gebaeudemodell\wand\web.wand\wand.nvt

Work 1

10 20 40

10 20 40

Wände mit neutralem Material

In der frühen Phase des Entwurfs wollen wir noch nicht über Materialien und Details nachdenken.

Diese Wände sind nur 1m hoch, wie z.B. Brüstungen.

Sie werden dünner als die anderen Wände dargestellt, da sie im Grundriss nicht geschnitten sind.

Work 2

Wand - Öffnung

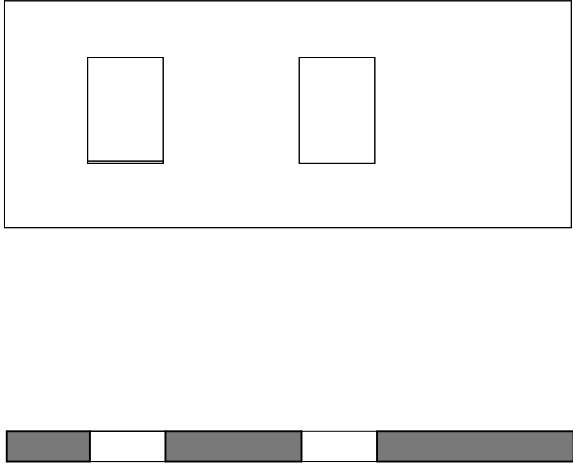

Wand - Ausparung

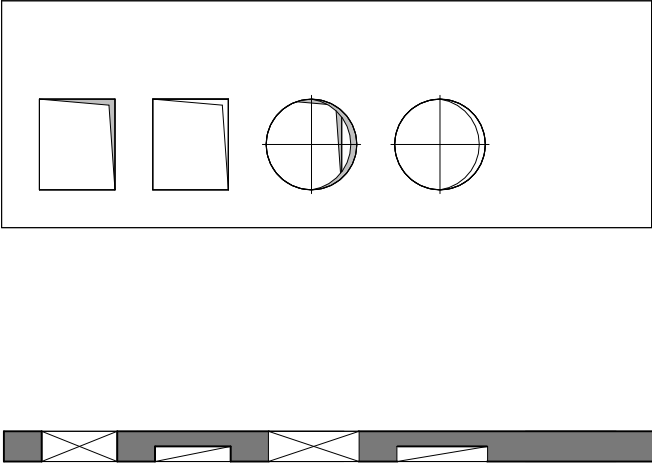

s7

s7